



MECB/SS

TÍTULO

ORBITAL MANEUVER STRATEGIES FOR ACQUISITION PHASE

CÓDIGO AP

AR

23/08/88
CONTROLADO POR: [Signature]
DATA: 02/08/88

PREPARADO POR

APROVAÇÕES

ASS. [Signature]
NOME Luiz C.G. Souza DATA 02/08/88

ASS. [Signature]
NOME Valdemir Carrara DATA 02/08/88

ASS. [Signature]
NOME Valdemir Carrara DATA 02/08/88

ASS. [Signature]
NOME Décio C. Ceballos DATA 02/08/88

ASS. _____
NOME _____ DATA / /

ASS. [Signature]
NOME Aydano B. Carleial DATA 02/08/88

ASS. _____
NOME _____ DATA / /

ASS. _____
NOME _____ DATA / /

ASS. _____
NOME _____ DATA / /

ASS. _____
NOME _____ DATA / /



PÁGINA	VERSÃO	DATA	REFERÊNCIA DA MODIFICAÇÃO	OBSERVAÇÃO
i	1	2.8.88		
ii	1	2.8.88		
iii	1	2.8.88		
iv	1	2.8.88		
1	1	2.8.88		
2	1	2.8.88		
3	1	2.8.88		
4	1	2.8.88		
5	1	2.8.88		
6	1	2.8.88		
7	1	2.8.88		
8	1	2.8.88		
9	1	2.8.88		
10	1	2.8.88		
11	1	2.8.88		
12	1	2.8.88		
13	1	2.8.88		
14	1	2.8.88		
15	1	2.8.88		
16	1	2.8.88		
17	1	2.8.88		
18	1	2.8.88		
19	1	2.8.88		
20	1	2.8.88		
21	1	2.8.88		
22	1	2.8.88		
23	1	2.8.88		
24	1	2.8.88		
25	1	2.8.88		
26	1	2.8.88		
27	1	2.8.88		
28	1	2.8.88		
29	1	2.8.88		
30	1	2.8.88		
31	1	2.8.88		



TABLE OF CONTENTS

1 - INTRODUCTION

1.1 - SCOPE

1.2 - THE TRANSFER ORBIT STRATEGIES

2 - APPLICABLE AND REFERENCE DOCUMENTS

2.1 - APPLICABLE DOCUMENTS

2.2 - REFERENCE DOCUMENTS

3 - PROBLEM FORMULATION AND RESULTS

3.1 - ORBITAL MANEUVER STRATEGIES

3.2 - BASIC EQUATIONS

3.3 - ORBIT TRANSFER PROCESS SIMULATION

3.4 - SIMULATION RESULTS

4 - CONCLUSIONS



1 - INTRODUCTION

1.1 - SCOPE

This work presents a detailed study and some simulations of strategies in orbit acquisition phase as response to the action S4 of document SSR Concept Review Synthesis.

1.2 - THE TRANSFER ORBIT STRATEGIES

The orbit transfer process is performed by impulsive thrust, applied suitably in a determined point of the orbit, causing it to rise from an initial orbit to the operational orbit.

This study intends to evaluate the following items, during the orbit transfer process, in order to define one or more strategies for the orbit acquisition phase.

- 1) Duration of the whole process and of each maneuver with its respective fuel consumption estimate.
- 2) Strategy of combining, or not, the orbit raising with the inclination correction maneuvers.
- 3) Study of the different intermediate orbits considering the stations' visibility.
- 4) The effect of the orbit disturbing factors over the maneuvers sequence.



2 - APPLICABLE AND REFERENCE DOCUMENTS

2.1 - APPLICABLE DOCUMENTS

REMOTE SENSING SATELLITE CONCEPT REVIEW. VOLUME II -
SATELLITE, A-REV-1000.

SSR CONCEPT REVIEW SYNTHESIS, A-REV-0059.

2.2 - REFERENCE DOCUMENTS

Kuga, H. K. e Silva, W. C. C. "Gerador numérico de
órbita de satélites artificiais terrestres". São
José dos Campos, INPE, 1984 (INPE-3050-RPE/455).



3 - PROBLEM FORMULATION AND RESULTS

3.1 - ORBITAL MANEUVER STRATEGIES

The implementation of any orbital maneuver strategy depends on the initial orbit geometry, which is a function of the error in the injection point.

As the launch dispersions of Remote Sensing Satellite (RSS) are less known, it is difficult to establish one or more strategies near the reality. Therefore, the critical case must be considered as possible and adopted as the worse case. Although the nominal injection orbit is specified as circular with 450 Km of altitude, a more distant orbit from the nominal one must be utilized in the acquisition prediction limits: altitude of perigee, 350 Km and altitude of apogee, 430 Km.

The dispersions due to the launch do not guarantee the perigee/apogee position over a pre-determined location. The best hypothesis would be that the perigee coincides with the injection point (approximately 8 degrees of latitude North). Two distinct strategies can be adopted if the perigee doesn't coincide with the injection point:

a) Carry out the maneuvers in visibility, outside the perigee and apogee points.

b) Carry out the maneuvers at apogee and perigee through time-tagged telecommands, previously stored in the onboard computer.

The advantages of the first strategy are:

i) More reliability on the maneuvers and on their results.

ii) Real time maneuvers attendance and monitoring.



iii) Possibility of orbit estimation and its adjustment after the maneuvers.

The disadvantages of the first strategy are:

i) An increase of hydrazine consumption, because of the non optimal orbit transfer.

ii) Possibility of combining the orbit rise with the inclination correction maneuvers, only through the maneuvers carried out near the equatorial passages (in the beginning and at the end of Cuiabá passages).

The advantage of second strategy is:

i) The optimization of hydrazine consumption and the time necessary for orbit transfer process.

The disadvantages of the second strategy are:

i) Impossibility of monitoring the orbit maneuvers due to the uncertainty in the perigee/apogee locations.

ii) Difficulty in the satellite signal capture in the visibility passage, after orbit correction, principally if the dynamic model of the impulse has large discrepancy with respect to the real one. The disadvantage increases with the time between the maneuver point and the entrance of the next contact with the Control Ground Station (Cuiabá), due to orbit errors propagation. Since up to six consecutive orbits without contact can occur during the transfer orbit phase, the maneuvers must take place only in the last orbit before the station contact (equivalent to store one telecommand for approximately eight hours).



iii) Impossibility of combining the semimajor axis with inclination maneuvers, except if the locations of the apogee and perigee are near the equatorial plane (nominal orbit injection with few dispersions).

Both strategies are conflicting with respect to the combined maneuvers. The implementation of the first one depends on a study related to the simultaneity between the ground station contact and the satellite equator crossing time. The implementation of the second strategy would probably need maneuvers to move the perigee argument to the equator line, but preliminary studies indicated a high hydrazine consumption to perform these maneuvers.

If there is priority to implement the combined maneuvers, one must adopt a strategy that is independent of the perigee/apogee location and ground station contact to carry out the maneuvers. This third strategy leads to:

Perform the combined maneuvers (semimajor axis/inclination) through stored commands near the equator crossing and, if possible, in visibility from Cuiabá.

It's important to emphasize that the successive maneuvers over the same point (in equator crossing) tend to bring the apsidal line (perigee/apogee) to this point.

As the geocentric radius is not perpendicular to the satellite velocity (except at the perigee and apogee), the maneuvers with the impulse direction perpendicular to the vertical, change the semimajor axis more than the orbital eccentricity. A study involving this strategy with a numerical orbit integration should be made to confirm its feasibility, as well as the maneuvers' impact over the orbital elements. The main advantage of this strategy is the possibility to perform combined maneuvers. The disadvantages are the difficulty to attend the maneuver during visibility, the non-optimal semimajor axis maneuvers with respect to the



hydrazine consumption and also the disadvantage ii of the second strategy.

Though the third strategy is more economical because of the combined semimajor axis/inclination maneuvers, there may occur some waste of hydrazine as the transfer trajectory is not optimal. This fact suggests that there is a compromise between the second and the third strategy, with respect to the hydrazine consumption to raise the semimajor axis and to perform the inclination correction. This can be seen supposing that the launcher sets right accurately the orbit inclination, favouring the second strategy, or, on the other hand, mistaking the orbit inclination, favouring the third strategy.

The total fuel consumption will define the limits between these two strategies, which will be analysed through a specific study.

Nevertheless, whatever the strategy will be, it is desirable to perform only one maneuver between two consecutive visibility passages so as to guarantee the satellite tracking during the whole orbit transfer phase.

For a better analysis, four simulations of the orbit transfer process were made. The first two simulations admit the possibility of two maneuvers per day at the equator, considering combined and separated maneuvers. The two last simulations also admit the possibility of two maneuvers per day, but in visibility from Cuiabá, considering combined and separated maneuvers. Some criteria such as fuel consumption and time to perform the maneuvers were considered in the simulation so as to compare the performance of the strategies. More details about the implemented strategies will be given in the simulation section.



3.2 - BASIC EQUATIONS

Due to the low altitude of the satellite during the orbit transfer process (between 350 km and 650 km, approximately), only the effects of gravitational field and the atmospheric drag were considered in the numerical integration. Thus the equations of satellite motion are:

$$\dot{R} = V \quad (1)$$

$$\dot{V} = G + D \quad (2)$$

with

$$G = - \mu / [R]^3 R$$

and

$$D = -1/2 C_d S/Mo p V_r [V + W_t R]$$

where:

μ = geogravitational constant

R = position vector

V = velocity vector

C_d = drag coefficient

S = satellite transversal section

M_o = initial satellite mass

p = atmospheric density

V_r = velocity of the satellite relative to the atmosphere

W_t = Earth rotation rate

The effects of the thrust are computed through the following expression, for the velocity increments DV:

$$DV = I_{esp} g \ln[M_o / (M_o - \dot{m} t)] \quad (3)$$



where:

I_{esp} = specific impulse

g = Earth gravity

\dot{m} = mass flow rate ($\dot{m} = F/I_{esp} g$)

F = gas jet force

t = time

The direction of the velocity increment depends on the kind of the implemented maneuvers. If only semimajor axis maneuver is desirable, the thrust must act in the Y_o direction (roll-axis) of the orbital coordinate system $X_oY_oZ_o$ (see Figure 1). Meanwhile, if it is desirable to perform only inclination correction maneuvers, the thrust must act in the Z_o direction, perpendicular to the orbital plane (pitch-axis).

For combined maneuvers, the satellite must turn in the yaw-axis about an angle such that the components of the velocity increment in the roll and pitch axis have the same ratio as the total velocity increments necessary to raise the orbit and to correct the inclination.

It is important to emphasize that the direction of each maneuver will depend on the correct association between the thrust direction and the orbital position of the spacecraft during the maneuvers, if they are performed in the ascending or descending node.

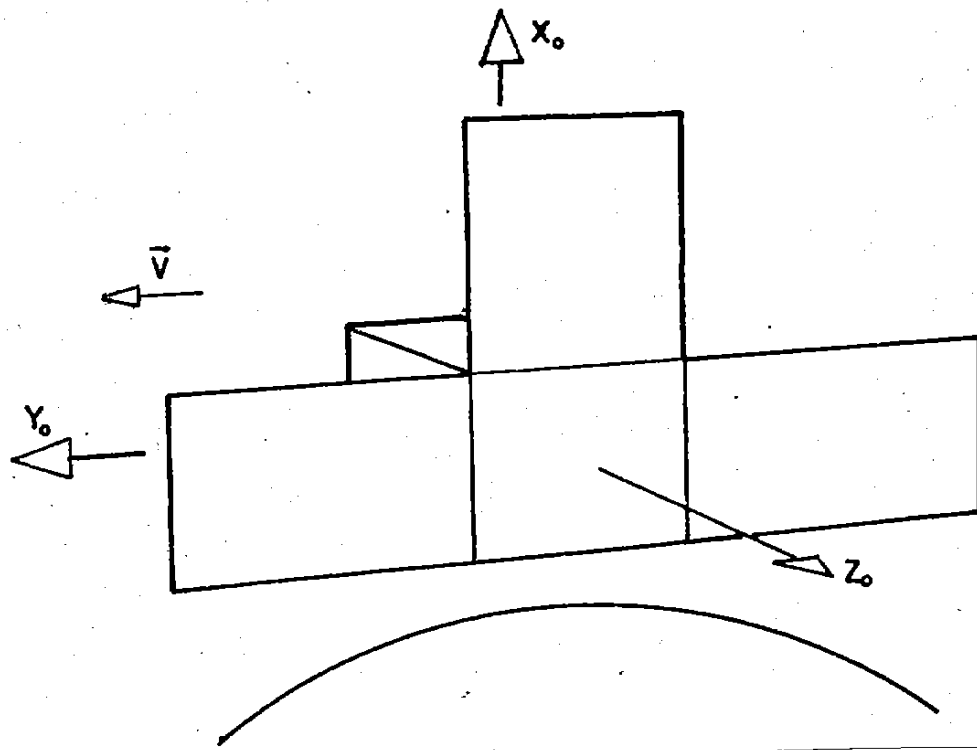

Fig. 1. Spacecraft orbital system.

As all the forces acting on the satellite were described in the orbital system, and the equations of the satellite motion were written in inertial coordinates, it is necessary to rotate the forces from the first system to the second one, using a matrix whose elements are given by the expressions:

$$P1 = \cos(w+f)\cos\Omega - \sin(w+f)\sin\Omega\cos i$$

$$P2 = \cos(w+f)\sin\Omega + \sin(w+f)\cos\Omega\cos i$$

$$P3 = \sin(w+f)\sin i$$

$$Q1 = -\sin(w+f)\cos\Omega - \cos(w+f)\sin\Omega\cos i$$

$$Q2 = -\sin(w+f)\sin\Omega + \cos(w+f)\cos\Omega\cos i$$

$$Q3 = \cos(w+f)\sin i$$



$$R1 = \sin \Omega \sin i$$

$$R2 = -\cos \Omega \sin i$$

$$R3 = \cos i$$

where:

i = orbit inclination

Ω = right ascension of the ascending node

w = argument of perigee

f = true anomaly

3.3 - ORBIT TRANSFER PROCESS SIMULATION

As said before, the strategy to perform the orbit acquisition phase is a function of the initial orbit geometry. Therefore, the simulation should consider a critical case, with some desfavorable aspects relative to the orbit geometry. The initial orbit is defined by the following parameters:

altitude of perigee = 350 km

altitude of apogee = 430 km

semimajor axis = 6768140 m

eccentricity = 0.00591

inclination = 97.94 degrees

longitude of ascending node = 67.27 degrees



argument of perigee = 97.66 degrees
mean anomaly = 270.00 degrees.

The constants used in the thrust simulation were:

specific impulse of hidrazine = 220 s
gravitational acceleration = 9.8 m/s²
gas jet force = 4 N
initial satellite mass = 170 kg

The relative position of some orbital events, as duration of ground station (Cuiabá) contact, eclipse duration, apsidal passages (where Δ represents the perigee and ∇ the apogee) and equator crossing time (here Δ represents the ascending and ∇ the descending node) of the initial orbit, are shown in Figure 2. The figure helps to identify some details necessary before beginning the maneuvers, as for example: the equator crossing does not coincide with the apsidal passage and the spacecraft is not in contact with Cuiabá during the descending equator crossing.

Figure 3 shows the orbital ground trace for the first twenty five orbits and the visibility circles of Cuiabá and Alcântara ground stations. The adopted strategy applied to this orbit reveals that the maneuvers could be performed in orbits number 7, 8, 12, 13, 23 and 24.

Two basic strategies were defined, based on the orbit analysis, to perform the maneuvers in the orbit acquisition phase:

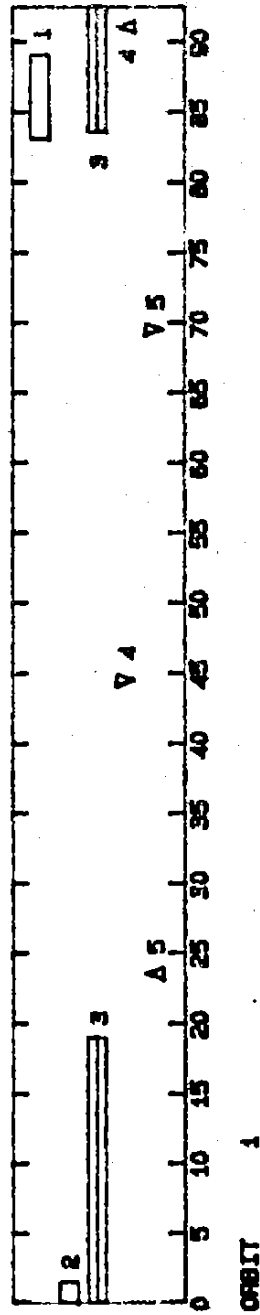

- 1 GUIABA
- 2 ALCANTARA
- 3 SHADOW
- 4 EQUATOR
- 5 APSIDAL

Fig. 2. Orbital events.

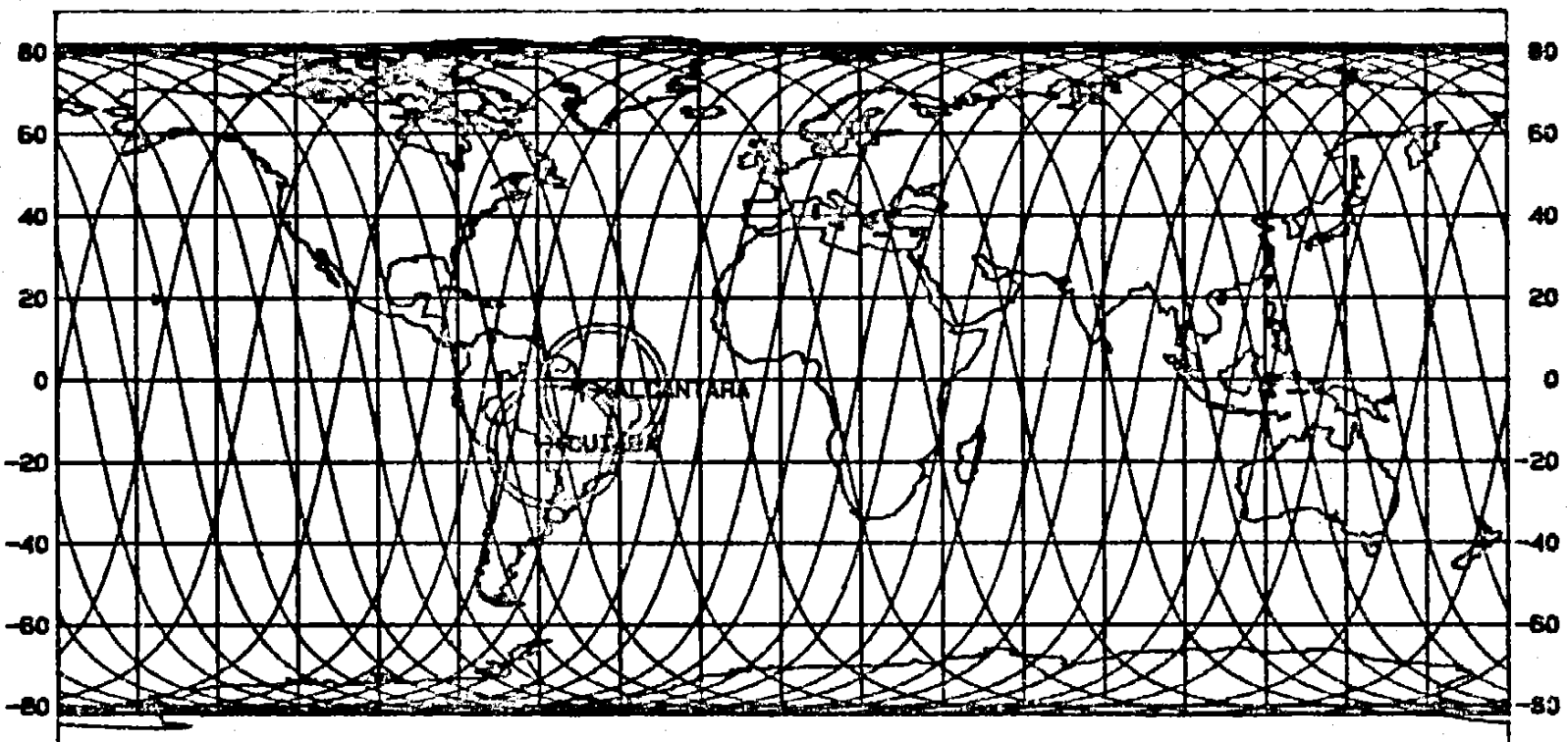

Fig. 3. Ground trace of the RSS injection orbit.



1) Maneuvers performed during the contact with the control ground station. If two or more consecutive orbits fall in this situation, the maneuver shall be realized in the first one, in order to permit the satellite tracking (and orbit determination) in the next orbit.

2) Maneuvers performed at the equator crossing (ascending or descending node), independently whether these points coincide or not with apogee or perigee.

Both strategies present maneuvers performed with a time interval sufficient to ensure the orbit determination between them. Thus, the effects of the orbit perturbations and thrust uncertainties can be detected along the maneuvers sequence.

To each one of these strategies, there can be considered semimajor axis combined with or separated from the inclination maneuvers. In the separated ones the semimajor axis is initially raised, followed by the inclination correction. The semimajor axis maneuvers shall be performed once in the morning passages and again in the night passages, while the inclination correction shall be made only once a day, at the ascending or descending node.

The transfer orbit phase shall be finished with the spacecraft in the drift orbit, which consists of a near circular orbit (eccentricity less than 0.0029), with the apogee not greater than the nominal altitude of operation (639.7 km).

The maneuver strategies must be analysed through the performance of several variables, among which are fuel consumption, duration of the maneuver cycle, versatility of maneuvers sequence and reliability.



3.4 - SIMULATION RESULTS

Four strategies were simulated: 1) separated semimajor axis/inclination maneuvers during contact with the ground station, 2) separated maneuvers at the equator crossing, 3) combined maneuvers in visibility of ground station and 4) combined maneuvers at equator crossing. It was tried to reach the final orbit with an altitude of the perigee of about 550 km (which allows safety circularization process), and to change the inclination value by about 0.5 degrees. A numerical integrator was used to propagate the orbit during the simulations (Kuga, 1984).

The Figures 4 to 9 show the behaviour of the semimajor axis, perigee, apogee, inclination, right ascension of ascending node and the hydrazine consumption in function of the number of the orbit, considering the first strategy.

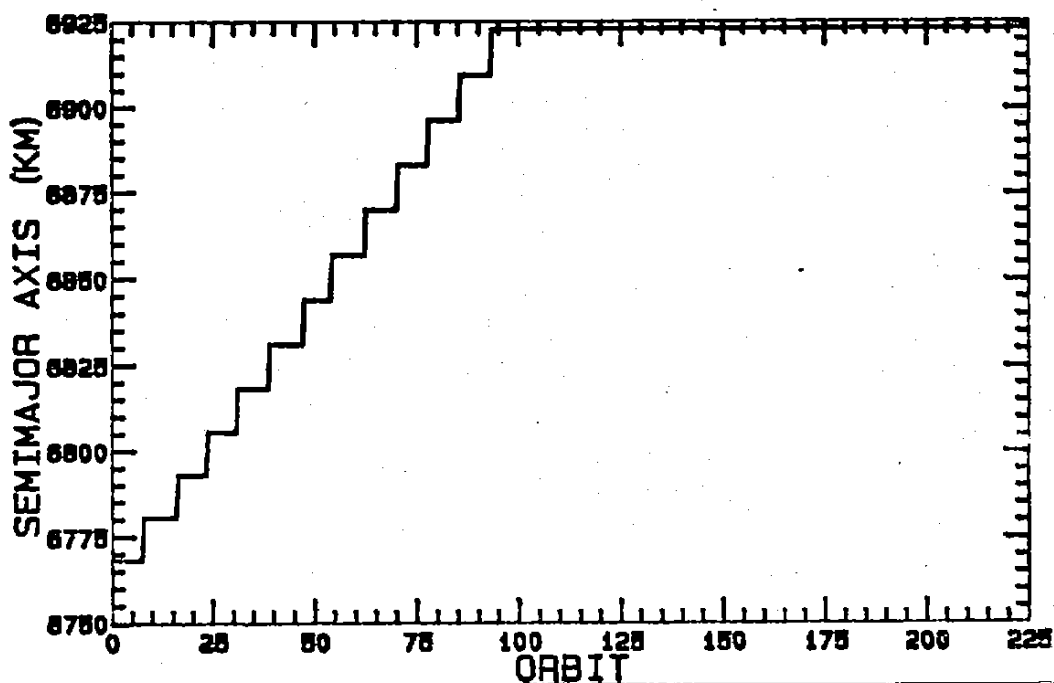

Fig. 4. Semimajor axis elevation. Separated maneuvers in visibility.

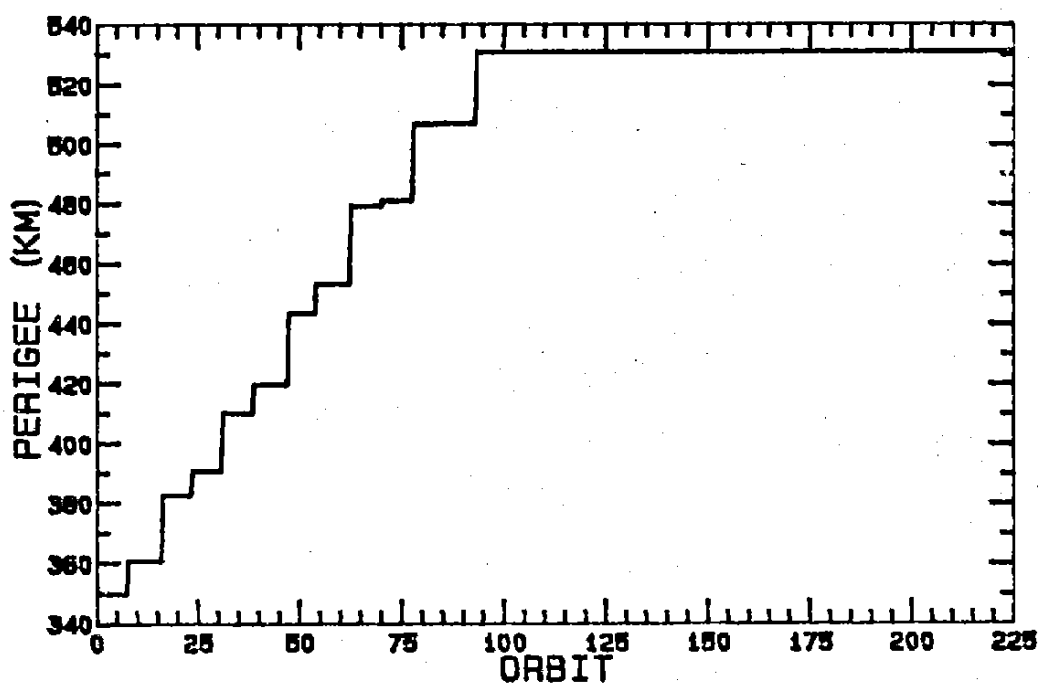

Fig. 5. Perigee elevation. Separated maneuvers in visibility.

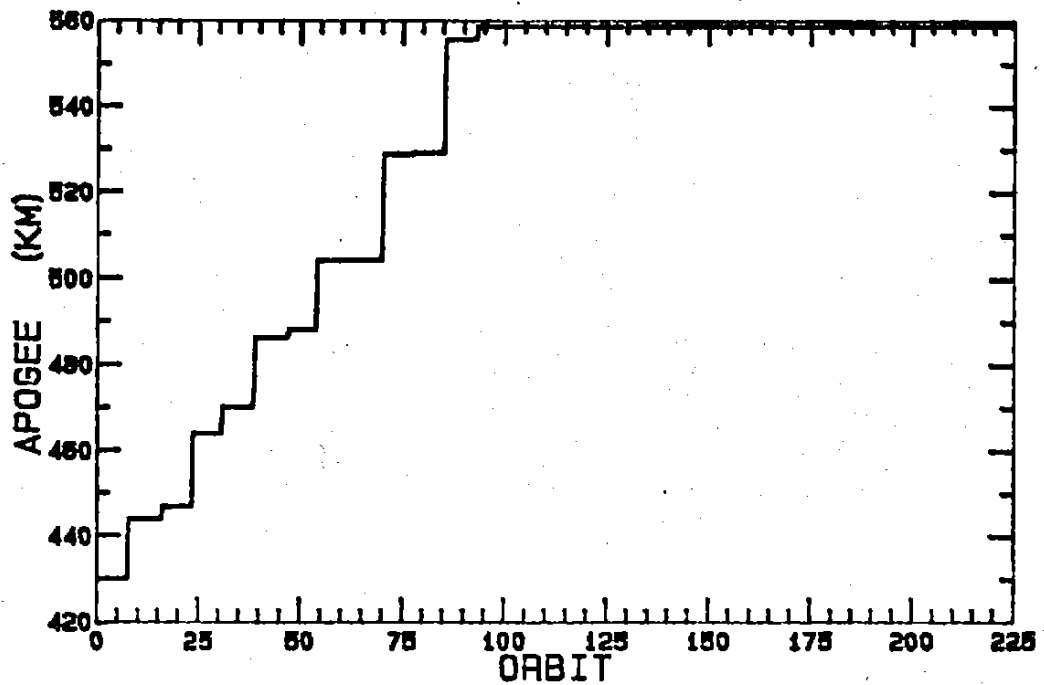

Fig. 6. Apogee elevation. Separated maneuvers in visibility.

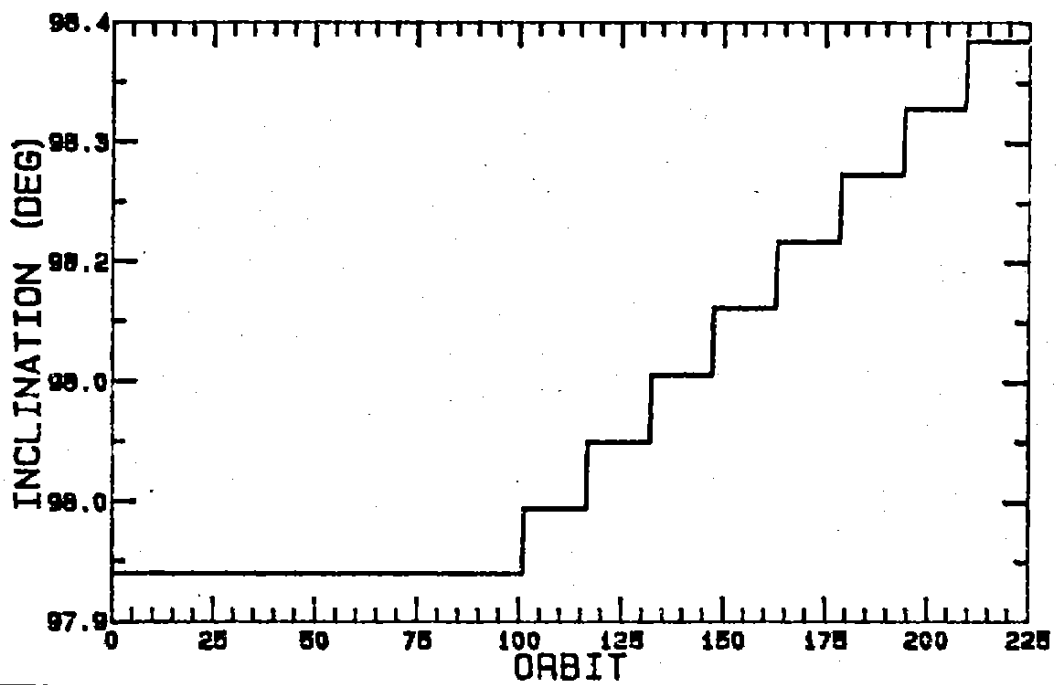

Fig. 7. Orbital inclination. Separated maneuvers in visibility.

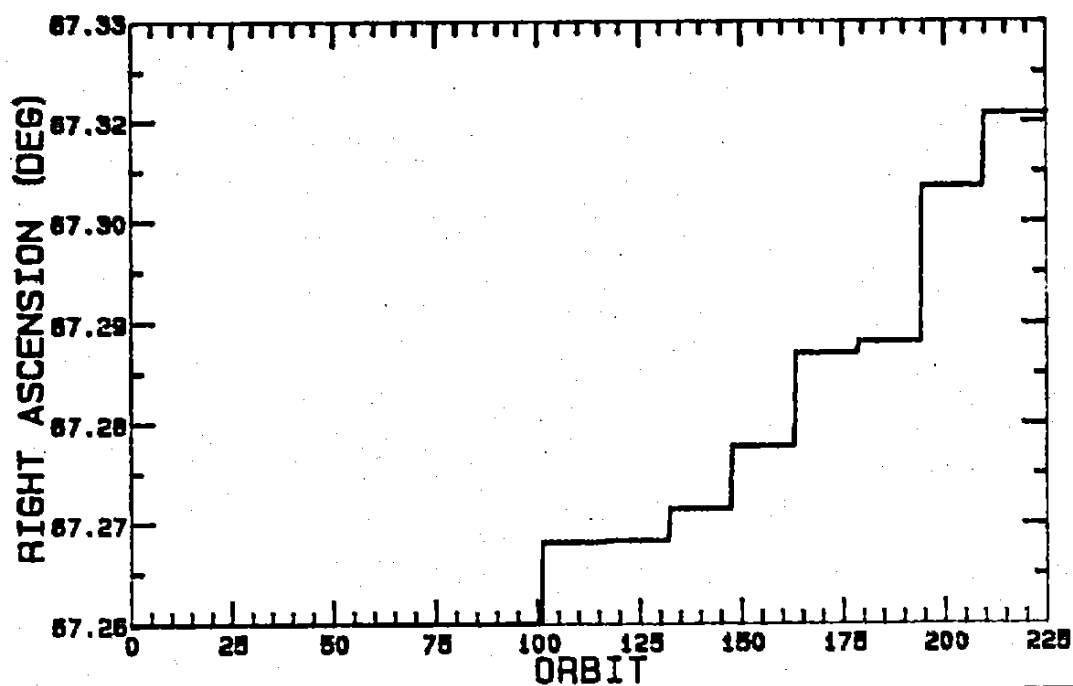

Fig. 8. Right ascension of the ascending node. Separated maneuvers in visibility.

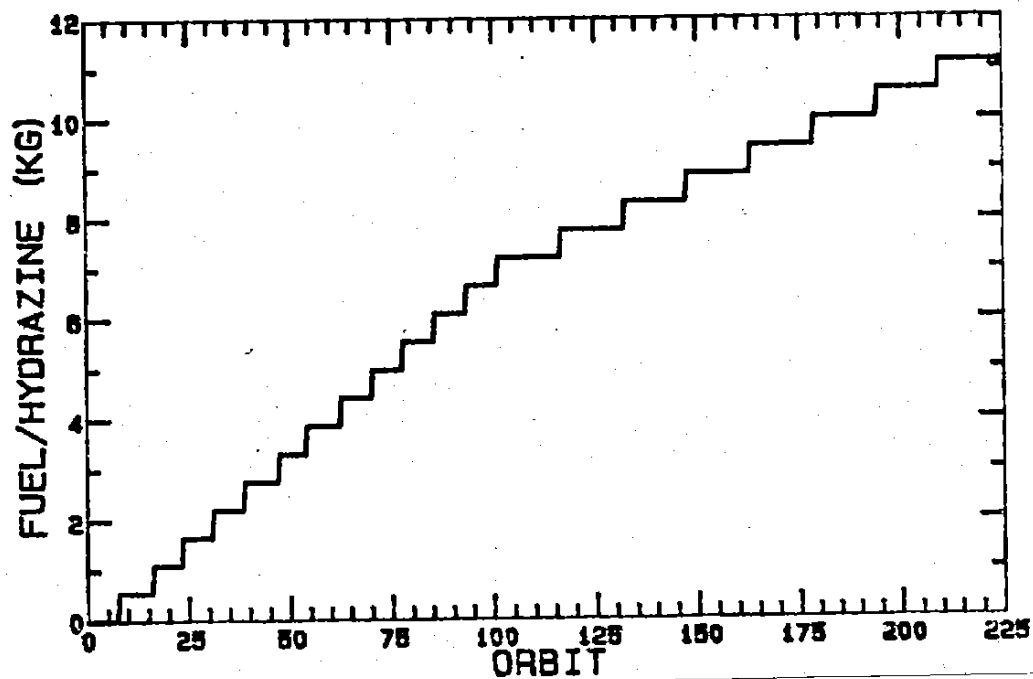

Fig. 9. Hydrazine consumption. Separated maneuvers in visibility.



It can be seen through these graphs that the semimajor axis reaches 6925 km approximately, the perigee 530 km, and the apogee 560 km, during the altitude raising sequence (starting at orbit 1 until orbit 99). Note that the inclination and the right ascension of the ascending node remain constant. In the inclination maneuvers sequence (starting at orbit 100 until orbit 210) the inclination changed from 97.94 to 98.39 degrees and the right ascension from 67.26 to 67.32 degrees, while the semimajor axis, the perigee and the apogee remain constant. The hydrazine consumption of the process was 11.1 kg, with a phase duration of 13.5 days, approximately.

The Figures 10 to 15 show the behaviour of the same parameters as before, for the second strategy.

As it can be noted in these figures, the semimajor axis reaches 6980 km, the perigee 550 km, and the apogee 640 km (after 125 orbits). As in the preceding strategy, the inclination and the right ascension remain constant. During the inclination correction sequence (starting at orbit 130 until orbit 190) the inclination changed from 97.94 to 98.45 degrees and the right ascension from 67.26 to 67.315 degrees. The total hydrazine consumption was 14.0 kg, during a period of 12.2 days, approximately.

The Figures 16 to 21 show the semimajor axis, perigee, apogee, inclination, right ascension of ascending node and the fuel consumption as function of the number of the orbit, using the third strategy.

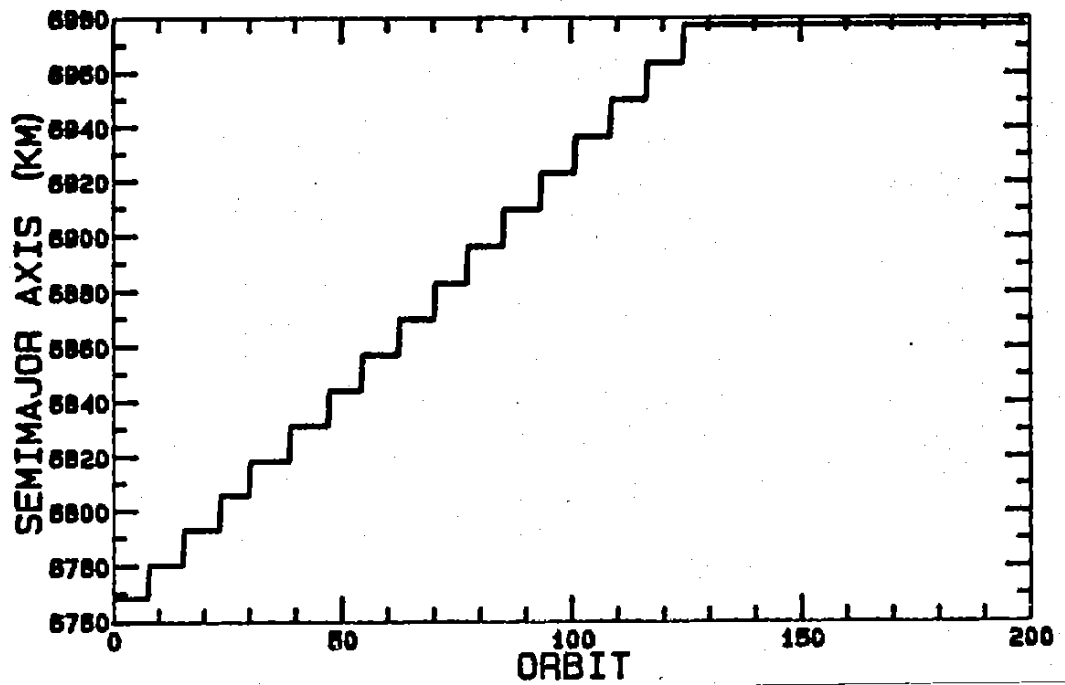

Fig. 10. Semimajor axis elevation. Separated maneuvers at equator crossing.

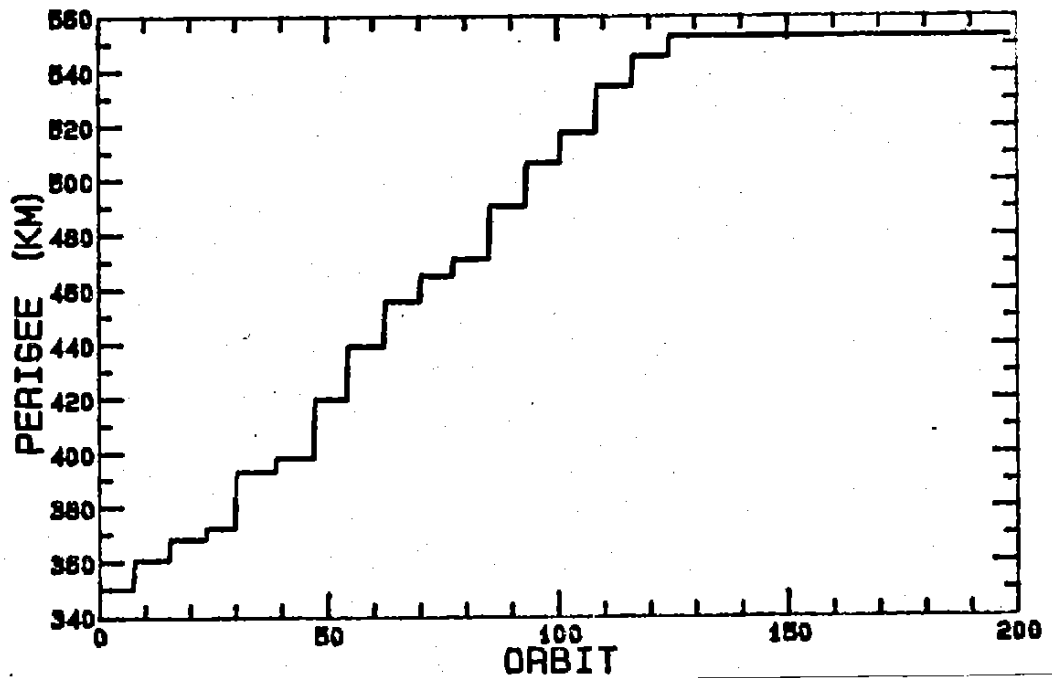

Fig. 11. Perigee elevation. Separated maneuvers at equator crossing.

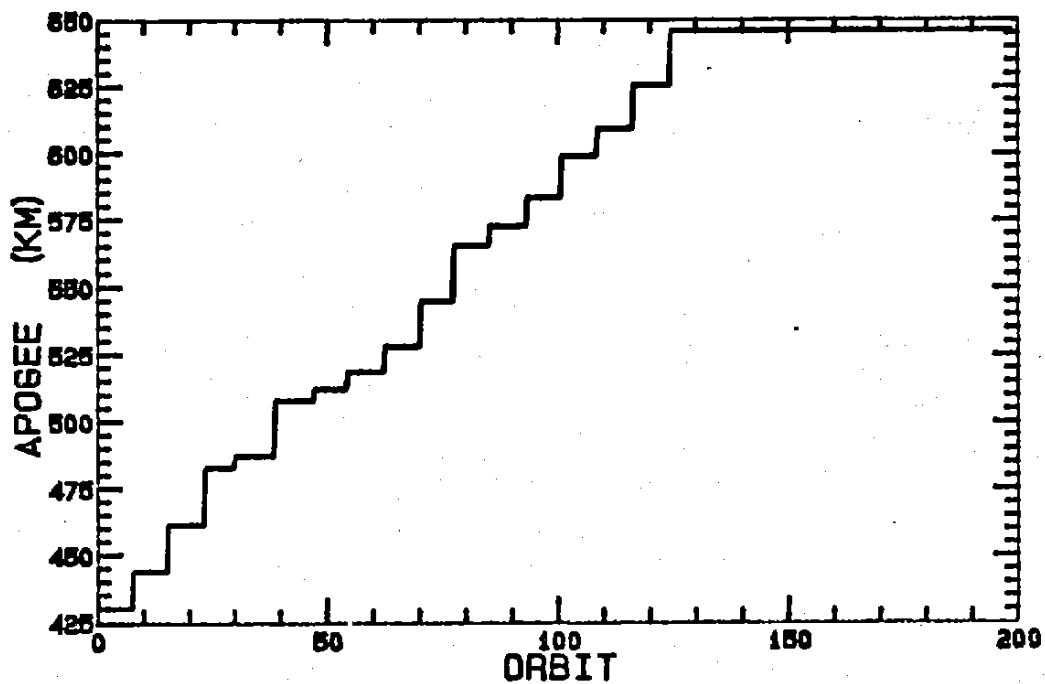

Fig. 12. Apogee elevation. Separated maneuvers at equator crossing.

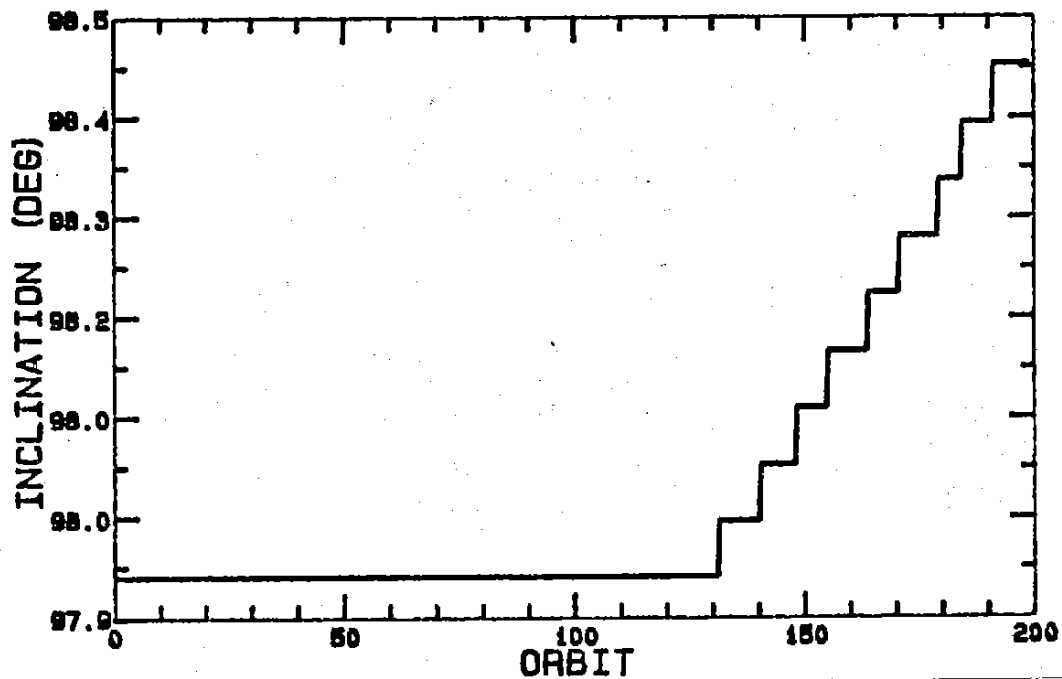

Fig. 13. Orbital inclination. Separated maneuvers at equator crossing.

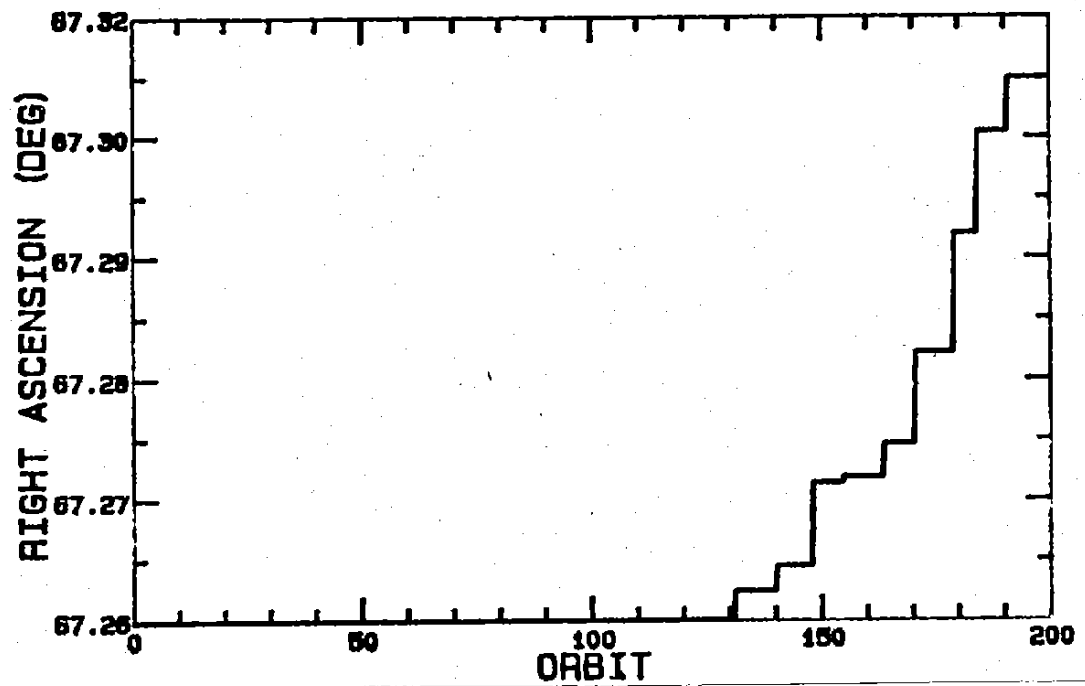

Fig. 14. Right ascension of the ascending node. Separated maneuvers at equator crossing.

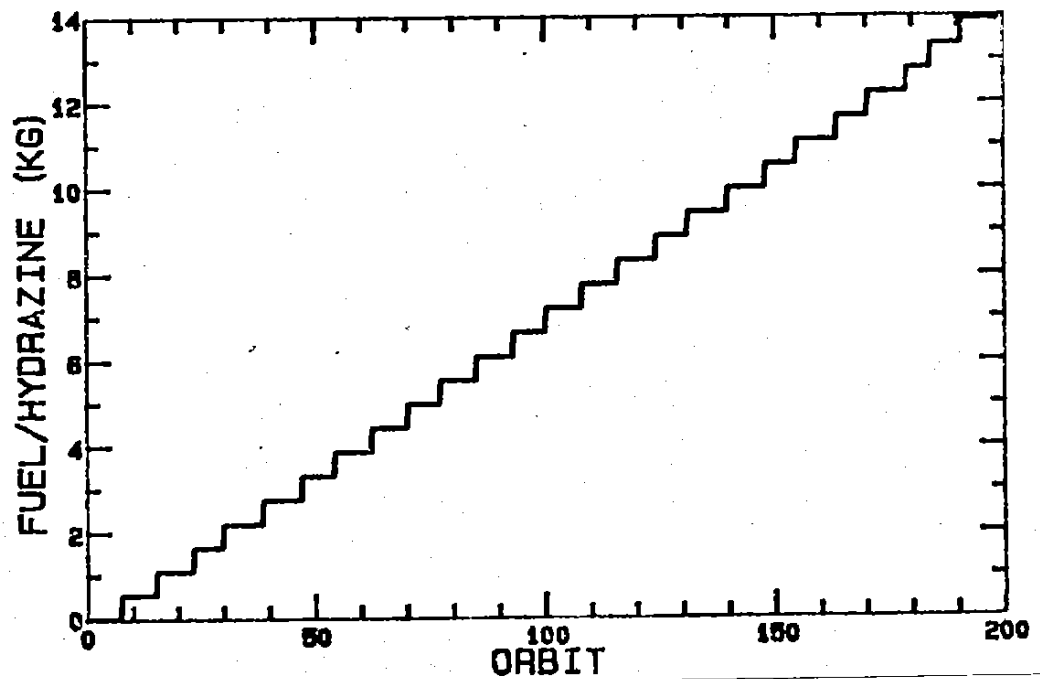

Fig. 15. Hydrazine consumption. Separated maneuvers at equator crossing.

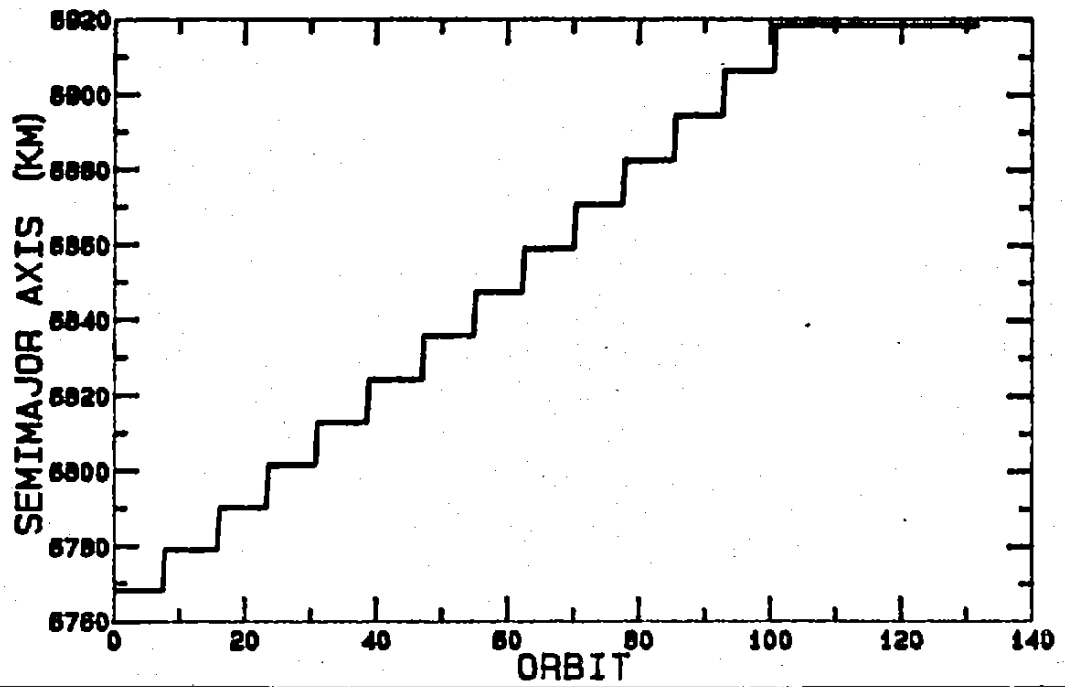

Fig. 16. Semimajor axis elevation. Combined maneuvers in visibility.

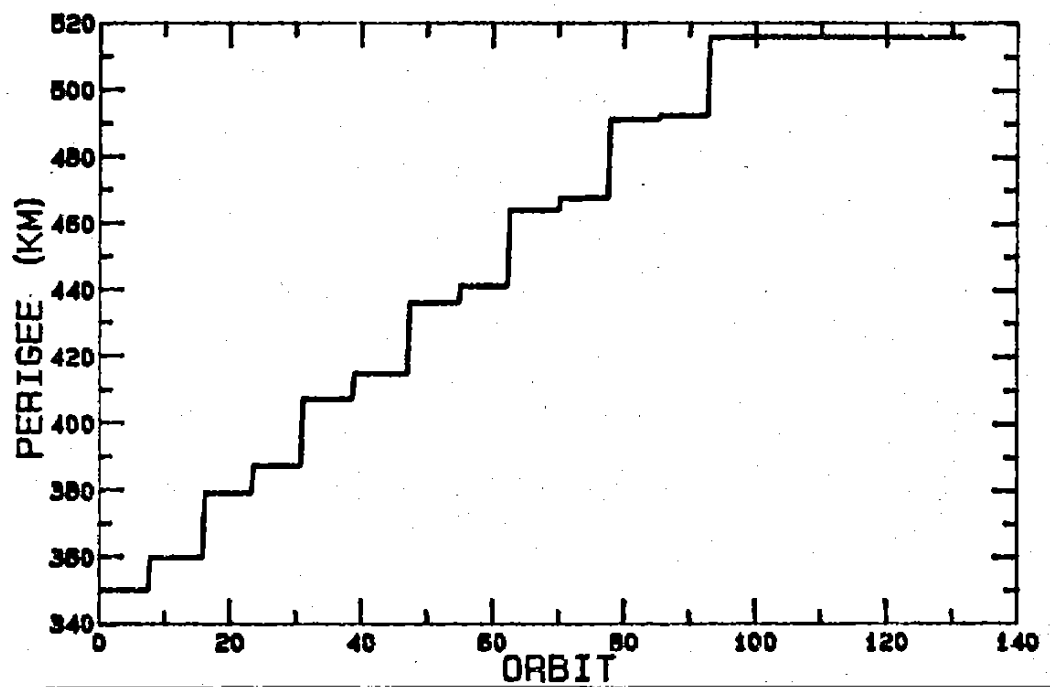

Fig. 17. Perigee elevation. Combined maneuvers in visibility.

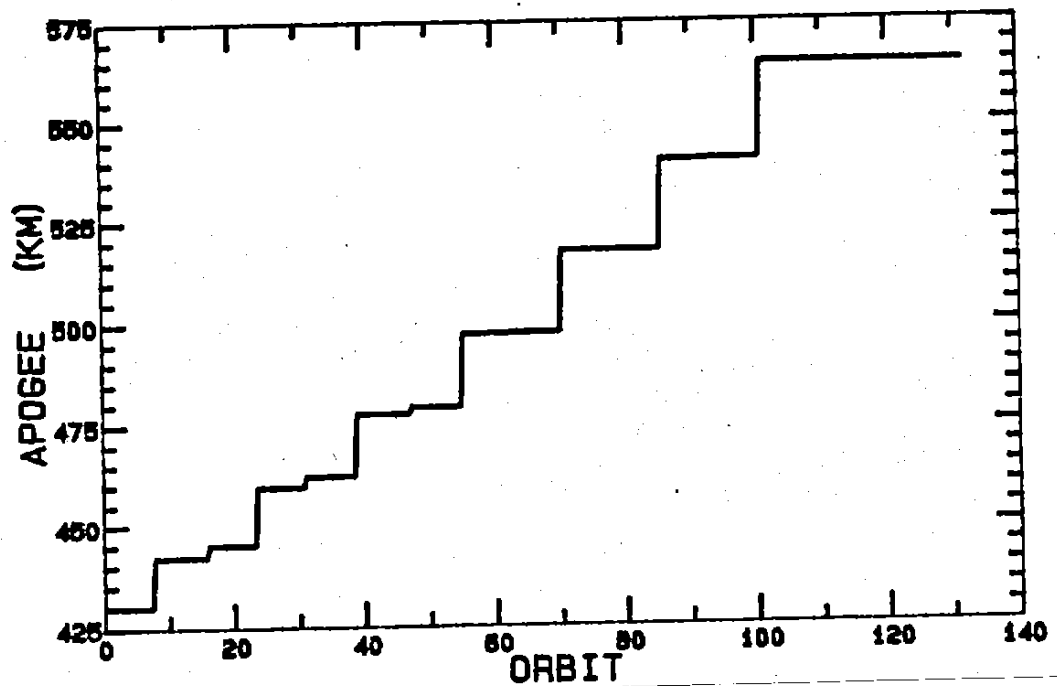

Fig. 18. Apogee elevation. Combined maneuvers in visibility.

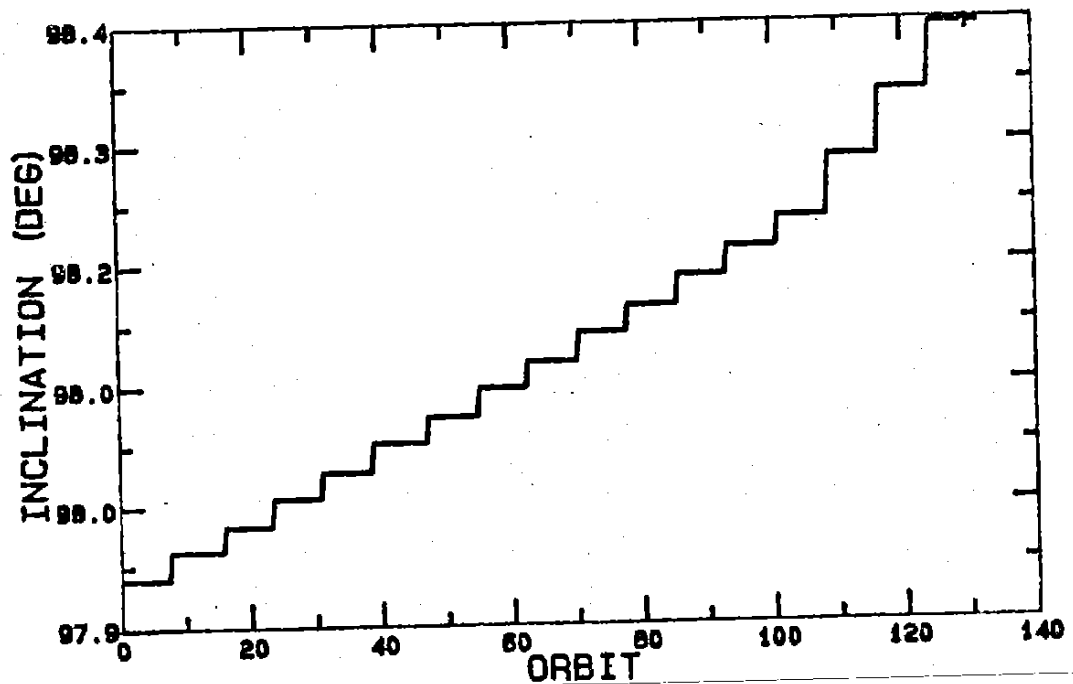

Fig. 19. Orbital inclination. Combined maneuvers in visibility.

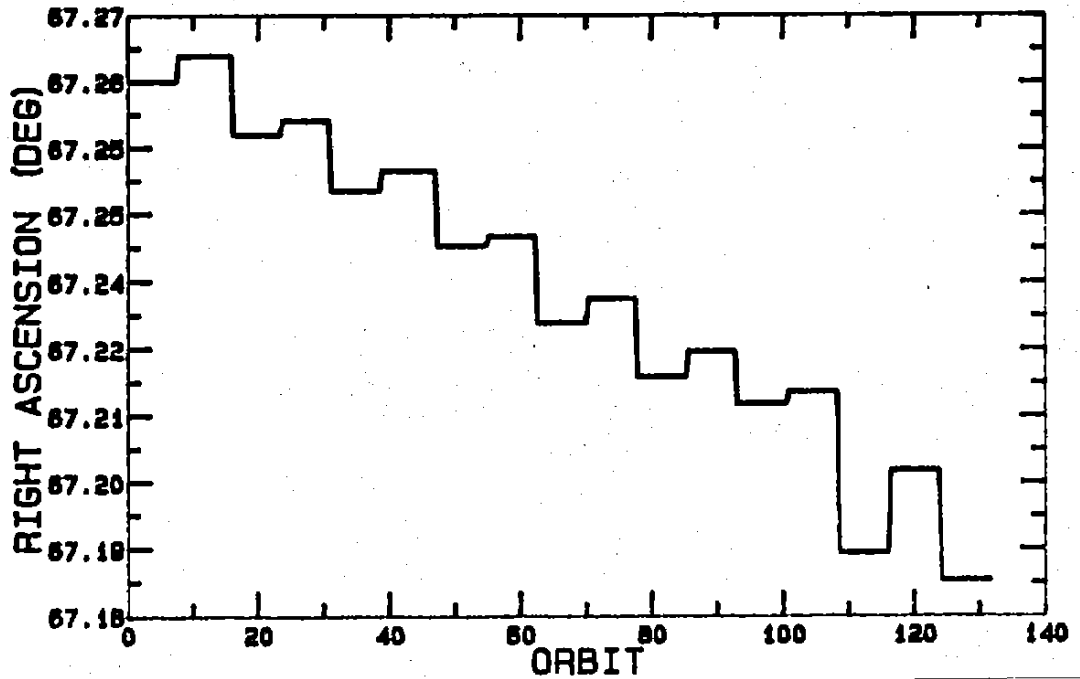

Fig. 20. Right ascension of the ascending node. Combined maneuvers in visibility.

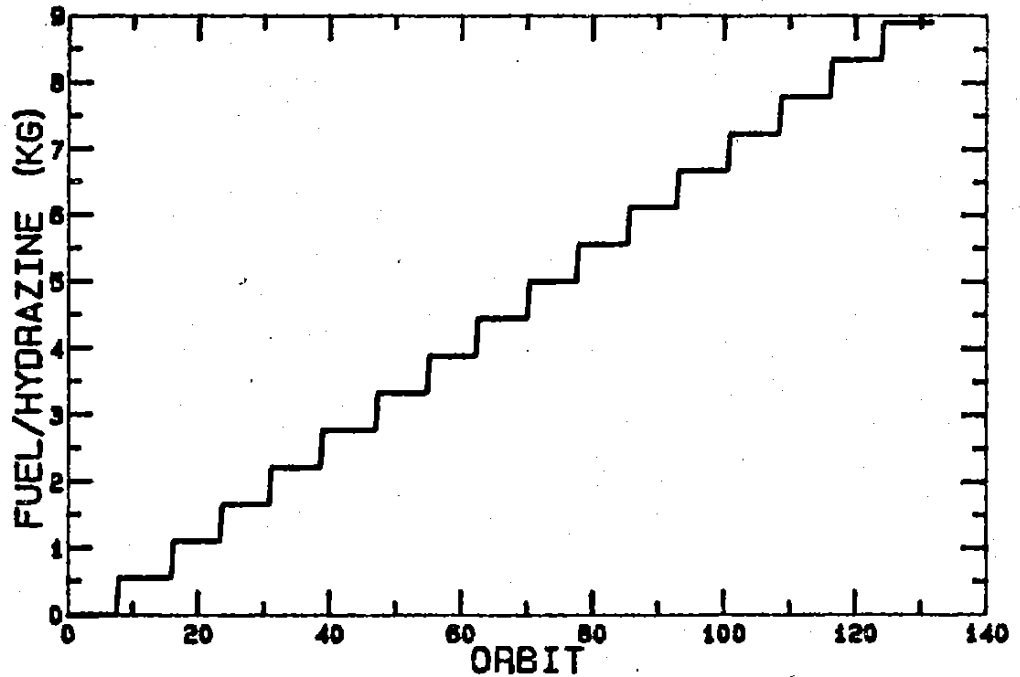

Fig. 21. Hydrazine consumption. Combined maneuvers in visibility.



In the combined maneuvers sequence, all the parameters present an almost linear variation during the whole phase duration (starting at orbit 1 until orbit 150). The final orbit reaches the following values: semimajor axis 6980 km, perigee 550 km, and apogee 650 km, with a 0.5 degrees of variation in the inclination and a negligible variation in the right ascension value. The hydrazine consumption was 10.5 kg, and the total phase lasts 9.0 days, approximately.

In the Figures 22 to 27, the combined maneuvers are performed at the equator (ascending or descending node). The sequence starts at orbit 1 and ends at orbit 150, when the semimajor axis reaches 6920 km, the perigee 520 km, and the apogee 565 km. The inclination changed from 97.94 to 98.40 and the right ascension presented again a negligible variation. The maneuvers last 8.3 days, with a fuel consumption of 8.9 kg.

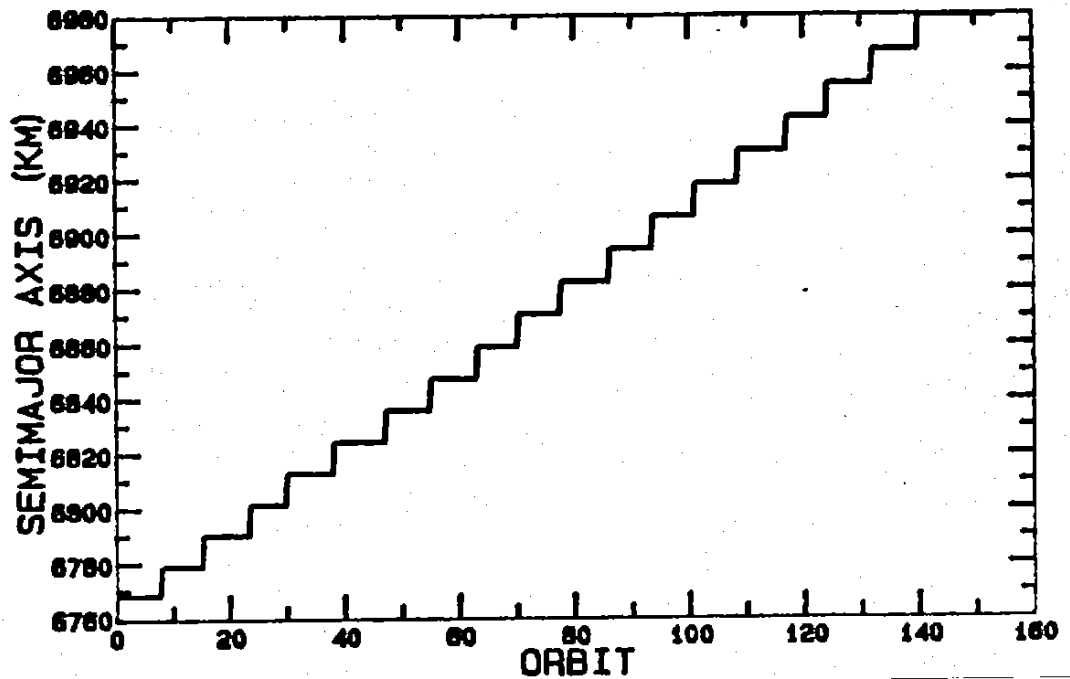

Fig. 22. Semimajor axis elevation. Combined maneuvers at equator crossing.

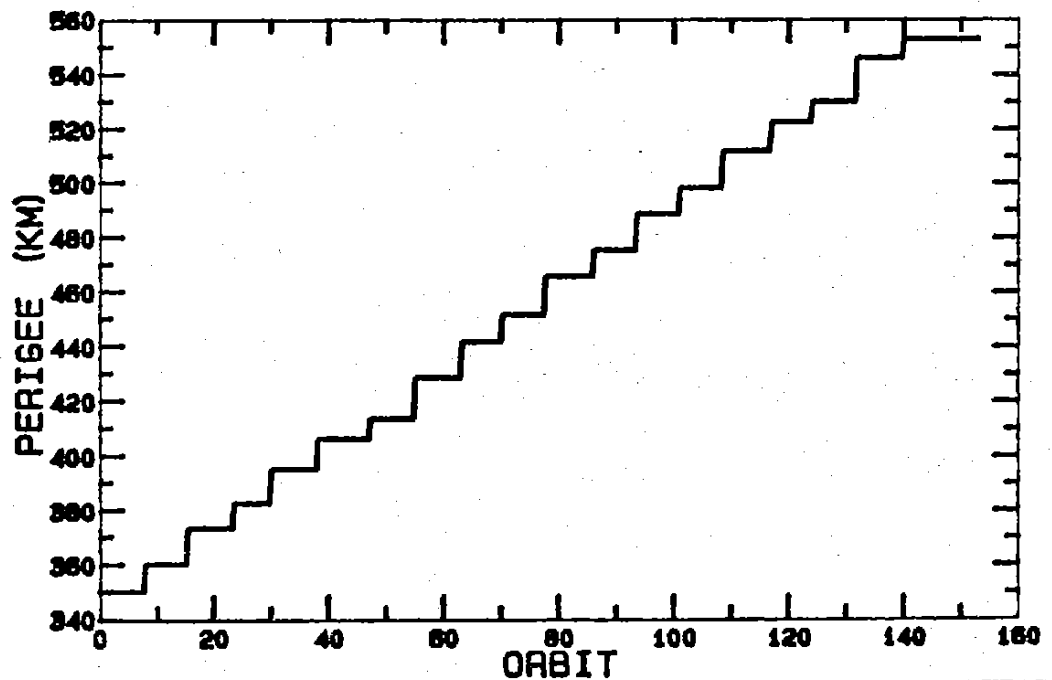

Fig. 23. Perigee elevation. Combined maneuvers at equator crossing.

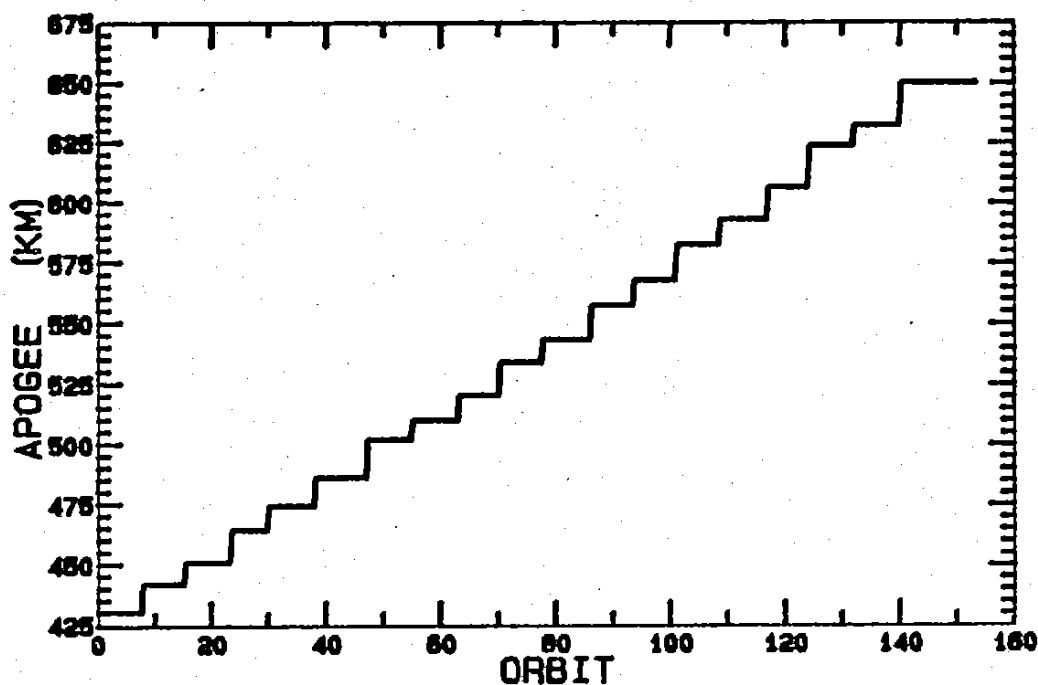

Fig. 24. Apogee elevation. Combined maneuvers at equator crossing.

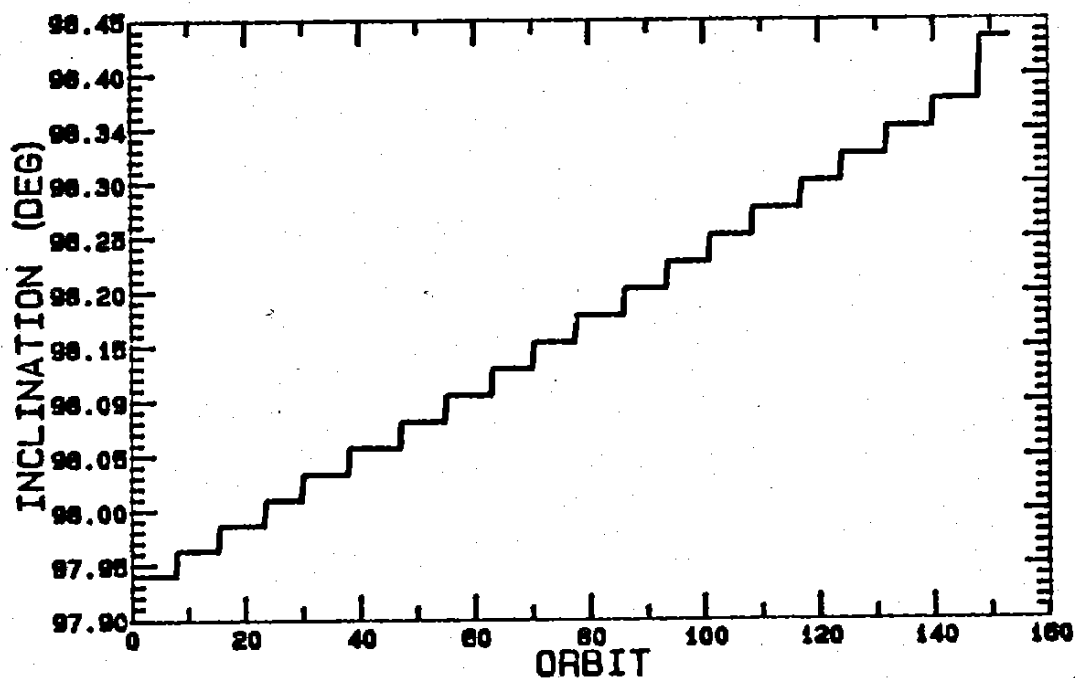

Fig. 25. Orbital inclination. Combined maneuvers at equator crossing.

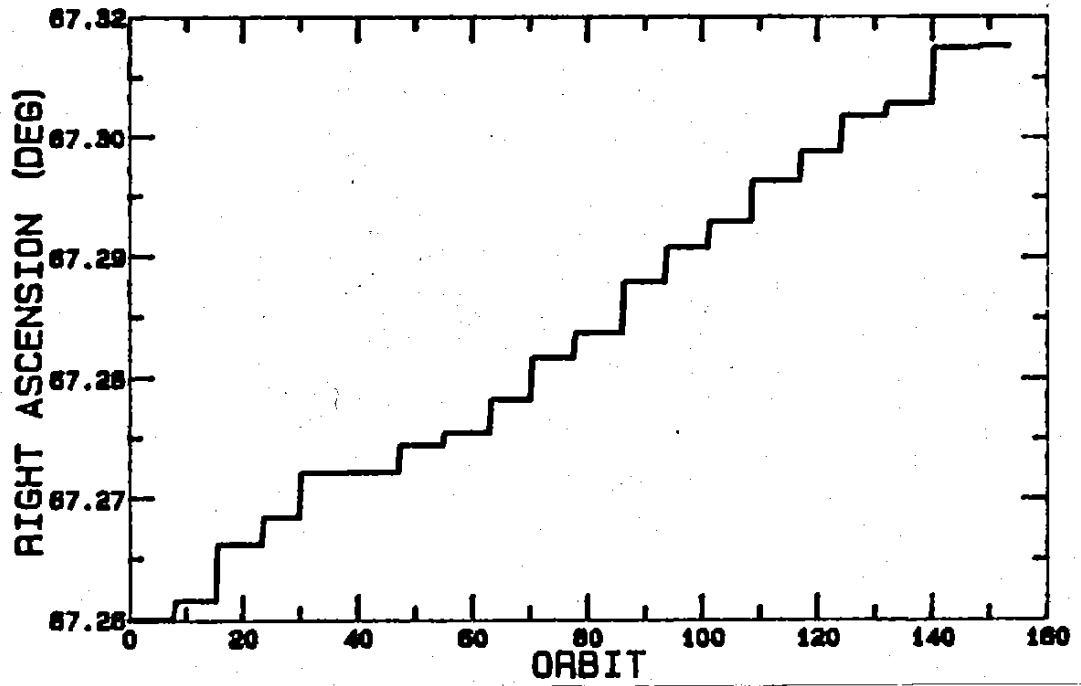

Fig. 26. Right ascension of the ascending node. Combined maneuvers at equator crossing.

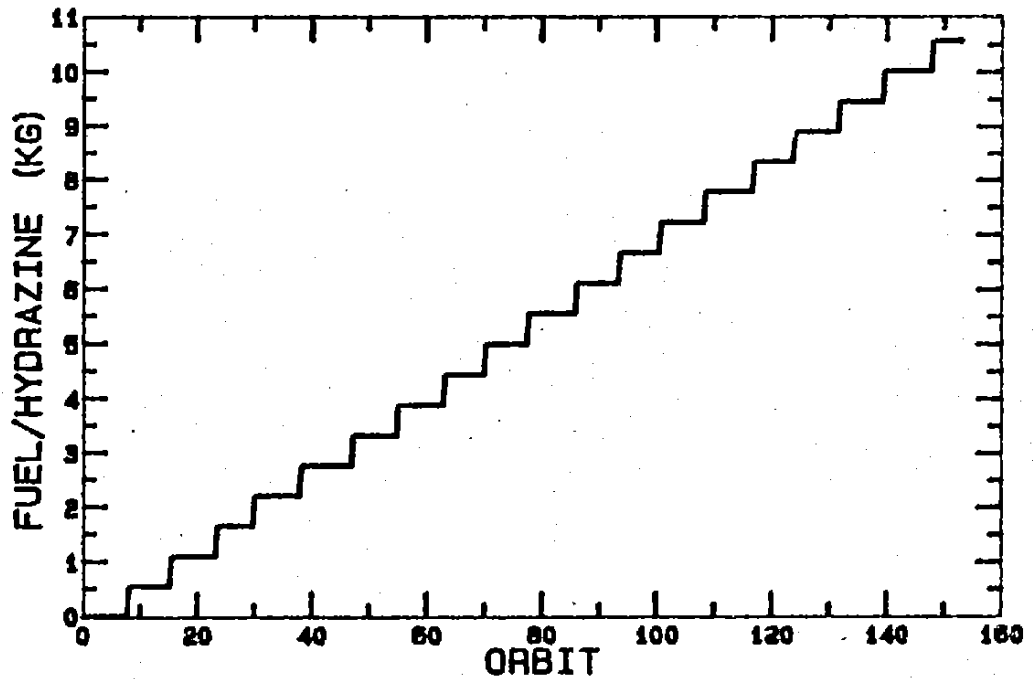

Fig. 27. Hydrazine consumption. Combined maneuvers at equator crossing.



4 - CONCLUSIONS

Combined maneuvers may represent a relatively large reduction in fuel consumption. During simulations, the fuel savings was up to 24%, approximately. The simulation also shows that there was no significant difference in the final orbit between maneuvers carried out at equator and maneuvers performed during contact with Cuiabá. Of course, the reason is the near equatorial location of the ground station. Maneuvers performed during visibility may be then a reasonable strategy, without a large expenditure of hydrazine. Nevertheless, the orbit circularization necessary to inject the satellite in the drift orbit shall be developed outside visibility interval, as there is no surety, a priori, about the exact final location of the apogee.

Although the results presented in the document "REMOTE SENSING SATELLITE CONCEPT REVIEW - VOL II - SATELLITE" shows an ideal situation, with Hohmann transfer maneuvers and without orbit perturbations, they are close to the values found in the simulation. Table 1 resumes some of the results and compares them with the analytical case. The values between parenthesis are extrapolated to the nominal operational altitude (639.7 km).



		Equator crossing maneuver	Maneuvers in visibility	Hohmann transfer
Combined maneuvers	semimajor axis (km)	6920	6980	7017
	hydrazine mass (kg)	8.9 (12.4)	10.5 (14.8)	11.6
Separated maneuvers	semimajor axis (km)	6980	6925	7017
	hydrazine mass (kg)	14.0 (15.6)	11.1 (15.2)	15.4

Table 1. Maneuver strategy comparisons.